



## **VCL-MX Version 3–DLX (Deluxe Version) 4 x E1, Drop-Insert Voice and Data Multiplexer**

---

### **VCL-MX, Voice and Data Multiplexer**

---

### **Product Brochure & Data Sheet**

#### **U.K.**

##### **Valiant Communications (UK) Ltd**

1, Acton Hill Mews,  
310-328 Uxbridge Road,  
London W3 9QN, United Kingdom  
E-mail: [gb@valiantcom.com](mailto:gb@valiantcom.com)

#### **U.S.A.**

##### **Valcomm Technologies Inc.**

4000 Ponce de Leon, Suite 470  
Coral Gables, FL 33146  
United States of America  
E-mail: [us@valiantcom.com](mailto:us@valiantcom.com)

#### **INDIA**

##### **Valiant Communications Limited**

71/1, Shivaji Marg,  
New Delhi - 110015,  
India  
E-mail: [mail@valiantcom.com](mailto:mail@valiantcom.com)

**Index**

<b>S. No.</b>	<b>Particulars</b>	<b>Page No.</b>
1.	Introduction	3
2.	Key Features	3
3.	Additional Features	4
4.	Highlights	4
5.	Transmission Mediums	4
6.	Multi-service platform	4
7.	Flexibility	5
8.	Configuration	5
9.	Synchronization	5
10.	Application of VCL-MX	5
11.	System Overview and Architectural Details	6
12.	Front View	7
13.	Back View	7
14.	Voice Interfaces	8
15.	Data Interface	8
16.	Chassis / System Backplane	8
17.	System Management	9
18.	Technical Specifications	10
19.	Application Diagram	22
20.	Ordering Information	29
21.	Support	34

## Product Overview:

The VCL-MX Version 3–DLX (Deluxe Version) 4E1 Multiplexer is a carrier class and cost-effective bandwidth provisioning equipment designed to manage and deliver services from the optical core to the access.

VCL-MX Version 3–DLX (Deluxe Version) 4E1 Multiplexer may be used for inter-connecting legacy voice and data networks, provisioning and managing

bandwidth on a E1 channelized level as well as 64Kbps, DS-0 time-slot level and as a digital-access cross-connect equipment. This 4 x E1 Multiplexer can be used in a Point-to-Point, Point-to-Multi point, Add-Drop (drop-insert), Tree and Star topology applications.



**VCL-MX Version 3 – DLX – Front View**

## Introduction

VCL-MX Version 3–DLX (Deluxe Version) – 4E1 Multiplexer may be used for inter-connecting legacy voice and data networks, provisioning and managing bandwidth on a E1 channelized level as well as 64Kbps, DS-0 time-slot level and as a digital-access cross-connect equipment. Due to the changing traffic patterns, there is a need to support multiple services from the same equipment like integrated data transport, better network management etc. This necessitated evolution to next-generation E1 Multiplexer. Single control card and redundant power supply options make it an ideal choice for network service providers seeking to integrate and provide legacy and the next generation services from a single platform.

The next generation E1 Multiplexer has emerged as one of the most economical and technologically viable solutions for transmitting both voice and data over carrier networks. This technology offers savings on investments/power and space to service providers.

Valiant Communications provides efficient solutions in this field using the E1 Multiplexer series products. E1 Multiplexer provides a full range of solutions in this evolving field of next generation telecom solutions. E1 Multiplexer family provides the unique advantage of carrying both data and voice over PDH. In addition to being affordable, these products have built-in modularity, which allow easy upgradeability. This upgradeability feature allows the customer to evolve in a “build-as-you-grow” concept. Along with Valiant Communications as a network management solution the E1 Multiplexer family provides the following features:

- Easy network manageability
- Lower cost per line
- Easy upgradeability
- Carrying both data and voice over PDH
- Easy integration to SDH network
- Higher reliability

## Key Features

VCL-MX Version 3–DLX (Deluxe Version) – 4E1 Multiplexer provides the advanced features and capabilities, listed below:

- 2Mbps, 4 E1 non-blocking cross-connect at 64Kbps (DS-0) level
- Single Control Card
- 1+1 Redundant Power Supply
- May be used in a Point-to-Point, Point-to-Multi point, Add-Drop (drop-insert), Tree and Star topology
- Telnet
- SNMP V2
- In-band and Out-of-band management
- GUI

## Additional Features

- Voice and Digital Data services
- Any combination ("mix-n-match") of voice and digital data services deployed from a single VCL-MX "Smart Shelf" - 2 channels per card
- Digital Data option may be used for internet access or video conferencing application
- Wireless applications including cellular networks
- Digital Microwave Radio
- SCADA applications
- ATM/Frame Relay circuit termination
- Powerful Network Management System for monitoring and network control
- Compliance with all relevant ITU-T (CCITT) recommendations
- 19-inch, 3U high construction.

## Highlights

- Field upgradable to provide voice, data or both services
- Flexibility on use of transmission medium-copper, fiber or wireless
- Choice of Interfaces for Voice and Data Applications
- RS232 and USB, Interface for local connection through the serial interface to the "Network Control and Management Software"
- 10/100BaseT Ethernet Management port for local and remote connection to the "Network Control and Management Software"
- In-band and Out-of-band system configuration and management interface
- Channel assignment independent of slot position in the sub-rack
- Extensive set of alarms
- User Selectable Internal, External or Loop-timed Synchronization clock options
- OAM Card in the system
- Any interface card can plug in at assigned interface slot.

## Transmission Mediums

The VCL-MX offers an excellent flexibility on the choice of transmission medium over which it may be deployed. The transmission medium can be either of the following:

- Copper
- Optical Fiber
- Wireless

## Multi-service platform

VCL-MX Version 3–DLX (Deluxe Version) – 4E1 Multiplexer supports both data and voice traffic. For voice traffic, it supports the following interfaces:

- FXO
- FXS
- E&M (2Wire / 4Wire)
- FXS-FXS (Hot-Line)
- Ring Generator (75V RMS)
- Magneto (GEN-GEN)

For data traffic, it supports the following interfaces:

- Channelized E1 / Fractional E1 Data
- RS232 asynchronous data
- V.24 asynchronous data
- G.703, @ 64 Kbps, co-directional synchronous data
- V.35, V.36, X.21, V.11, RS442, RS530, “n”x64Kbps synchronous data
- 10BaseT Bridge Interface Card
- Analog I/O Interface Card (Dry Relay Contacts)
- Digital I/O Interface Card (Digital TTL Signal Transfer Card)
- “N”x64Kbps Universal Data Interface Card (user configurable data interface)
- Complete Capability to Cross Connect Voice and Digital data between 4 incoming E1 ports (i.e. 4 separate connecting E1 links)

**Flexibility**

It can be configured in various topologies supporting electrical interfaces. It can take modular cards, which would enable the customers to start small and grow as traffic demands scale.

**Configuration**

VCL-MX Version 3–DLX (Deluxe Version) – 4E1 Multiplexer can be configured as an Add-Drop Multiplexer (ADM) and Terminal Multiplexer (TMUX). It can support diverse topologies like point-to-point, ring, star and tree.

**Synchronization**

Timing Options	Internal Clock, Loop-Timed Clock, External Clock
Synchronization Sources	Internal Clock, span clock timing derived from incoming HDB3 links (Loop-Timed), External Clock, 75 Ohms 2 MHz (TTL), 2.048 Mbps (BITS) Clock.
Default Option	Internal Clock (Stratum 3)

**Application of VCL-MX**

POTS (voice), digital data or real-time video conferencing services (V.35, V.36, X.21, 10BaseT Ethernet Bridge) high-speed digital data interface options allow point-to-point network solutions for providing a video conferencing channel of up to 1920 Kbps).

- Junction Mux – for digital interconnection of analog exchanges
- Point-to-Point, Point-to-Multi point, Add-Drop (drop-insert), Tree and Star topology applications
- Wireless network applications
- High-speed data ports for digital communication links providing Leased Lines access to Internet Service Providers (ISPs) with speeds ranging from 64Kbps up to 1920 Kbps digital data interface options
- Micro-Cellular infrastructure applications for providing cell-switch connectivity
- Wide area networking
- Internet access over POTS lines – all POTS interfaces operate @ 64Kbps and support V.34 (33.6Kbps) dial-up modems.

## System Overview and Architectural Details

The VCL-MX Version 3–DLX (Deluxe Version) – 4E1 Multiplexer provides full range of POTS (voice) and digital data services to subscribers located at different locations, requiring interconnecting and establishing a voice and data network over an E1 Link. The VCL-MX is a simple, yet powerful E1 Channel Bank for connecting and integrating analog communication equipment with digital E1 services.

The VCL-MX Version 3–DLX (Deluxe Version) – 4E1 Multiplexer provides cross connect, voice telephony and digital data services for applications.

E1 Multiplexer platform has been envisaged to address the growing demand for an ultra-compact Add-drop Multiplexer (ADM) and provide Ethernet-over-PDH mapping functions. It can be configured in various topologies such as linear, star, ring and bus.

VCL-MX Version 3–DLX (Deluxe Version) – 4E1 Multiplexer has a multi-slot chassis with TDM backplane. In the chassis, there are thirteen (13) traffic slots meant for tributary cards (line cards). The line cards can support various types of interface cards, which include E1, Voice and various types of serial synchronous data interface.

The VCL-MX Version 3–DLX (Deluxe Version) has 10 slots for the following interfaces:

- FXO
- FXS
- E & M (2-wire and 4-wire)
- Hotline
- RS232 / V.24 asynchronous
- RS485
- G.703 @ 64 Kbps, co-directional
- Magneto (GEN-GEN)

The VCL-MX Version 3–DLX (Deluxe Version) has 3 slots for the following interfaces: @ “N”x64 Kbps

- V.35
- V.36
- X.21
- RS530
- 10BaseT Bridge Interface Card
- V.11
- RS442
- Fractional E1 (FE1)
- Analog I/O Interface Card (Dry Relay Contacts)
- Digital I/O Interface Card (Digital TTL Signal Transfer Card)

The VCL-MX Version 3–DLX (Deluxe Version) has one slot for Ring Generator (75V RMS) Card, one slot for Control Card, one slot for OAM Card, one slot for the Power Supply and one slot for the Redundant Power Supply Card.

### Analog I/O Interface Card (Dry Relay Contacts)

**Description:** This interface card provides 8 Analog I/Os which may be used to extend either Dry Relay Contacts (Relay Normally-Open or Relay Normally-Close) or operate switches remotely (using 2A Dry Relay Contacts) between any two multiplexers using a 64 Kbps time-slot. The Dry Relay Contacts are rated at maximum 2 Amps, 30 Volts DC.

### Digital I/O Interface Card (Digital TTL Signal Transfer Card)

**Description:** This interface card provides 8 digital I/Os which may be used to either extend digital I/O's (logic high / low) signals between any two E1 Multiplexers or operate switches remotely (using logic high/low) signals between any two multiplexers. Drivers / Sense Logic operate using external voltage and ground references).

**VCL-MX Version 3-DLX (Deluxe Version) - Front View**

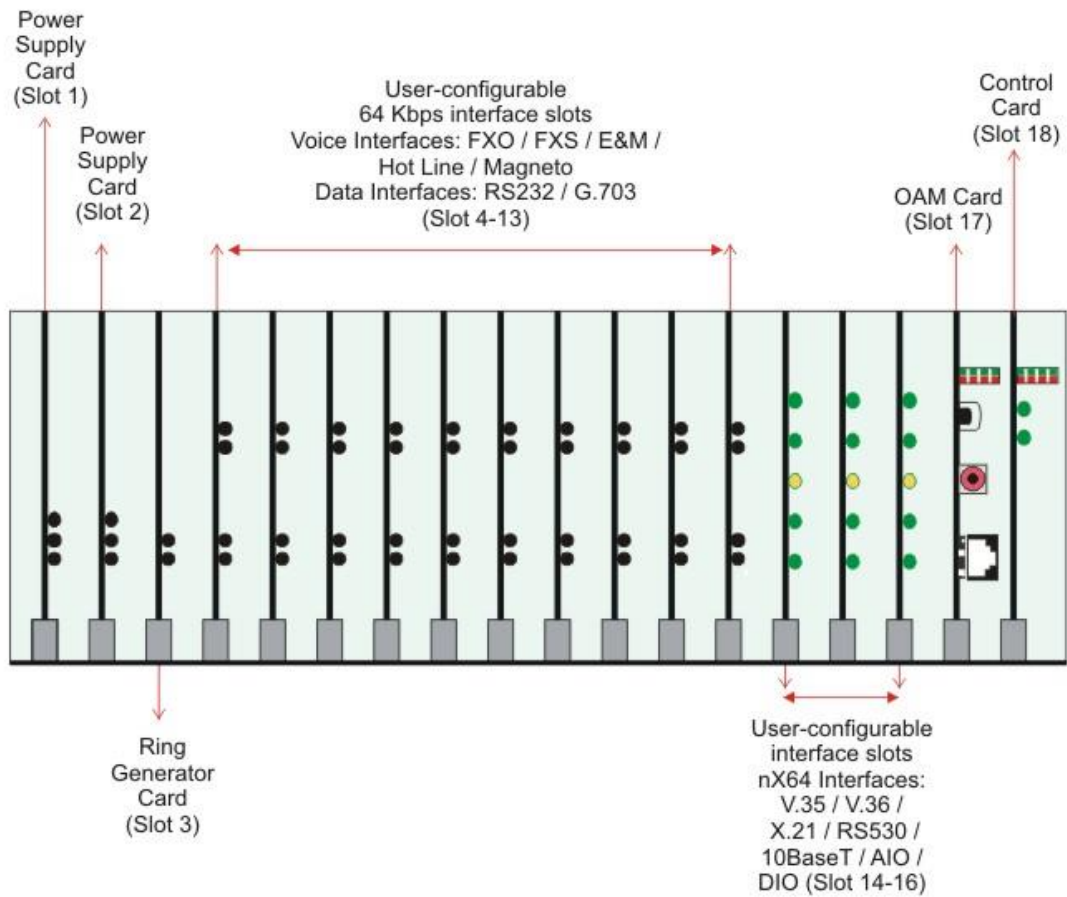

**VCL-MX Version 3-DLX (Deluxe Version) - Back View**

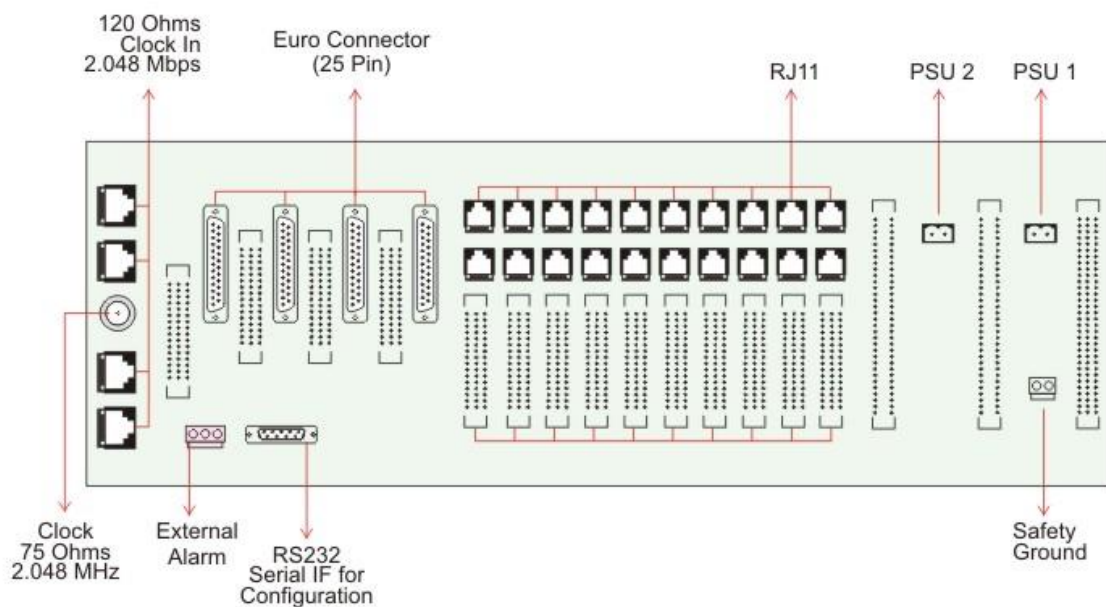

**The Multiplexer may be used in Terminal or Drop-Insert configuration to provide:**

- Toll Quality Voice Services
- Interconnect LAN (Campus Network)
- Interconnect computer terminals various types of data terminals
- Provide LAN-WAN Interconnectivity

**Voice Interfaces**

For voice traffic, it supports the following interfaces:

- FXO
- FXS
- E&M (2-wire and 4-wire)
- Hot-Line (FXS-FXS)
- Ring Generator (75V RMS)
- Magneto (GEN-GEN)

**Data Interfaces**

- Channelized E1 / Fractional E1 data with full cross-connect capability at 64Kbps, DS-0 level
- RS232 asynchronous data
- V.24 asynchronous data
- RS485 asynchronous data
- G.703, @ 64 Kbps, co-directional synchronous data
- V.35, V.36, X.21, V.11, RS442, RS530, "n"x64Kbps synchronous data
- 10BaseT Bridge Interface Card
- Fractional E1 (FE1)
- Analog I/O Card (Dry Relay Contacts)
- Digital I/O Card (Digital TTL Signal Transfer Card)
- Universal DCE / DTE synchronous "n"x64Kbps data interface

**Chassis / System Backplane**

All connections are made at the rear of the chassis, providing interconnections between the various plug-in cards and to the network. VCL-MX Version 3–DLX (Deluxe Version) - 4 E1 Multiplexer supports high-density PDH cards. The line cards can terminate a combination of Voice, Data and E1 Interfaces.

The VCL-MX Version 3–DLX (Deluxe Version) - 4 E1 Multiplexer has a 2Mbits/sec back-plane and provides a host of features including, channel drop and insert facility over a network of VCL-MX Version 3–DLX (Deluxe Version) - 4 E1 Multiplexers for voice and data applications.

An extensive set of alarms for easy maintenance, are provided in the system.



## System Management

VCL-MX Version 3–DLX (Deluxe Version) - 4 E1 Multiplexer offer a variety of management options, The VCL-MX E1 multiplexer management software can be configured using CLI (English text) commands and GUI (Graphical User Interface). The management and configuration commands may be executed from a VT100 terminal, Windows HyperTerminal, any DOS based system, Linux or Unix based system or Telnet (remote management).

The VCL-MX has an effective CLI (text) and GUI based "Network Management Interface", which may be used for configuring the system.

## Management Port and Control Interfaces

<ul style="list-style-type: none"><li>• Serial Management Port - RS232 Interface</li></ul>
<ul style="list-style-type: none"><li>• USB Serial Port</li></ul>
<ul style="list-style-type: none"><li>• 10/100BaseT Telnet over a TCP/IP Network</li></ul>

## System Access and Management

<ul style="list-style-type: none"><li>• Windows XP and Windows 7 compatible GUI (Graphical User Interface)</li></ul>
<ul style="list-style-type: none"><li>• Telnet - CLI (Command Line Interface)</li></ul>
<ul style="list-style-type: none"><li>• SNMP V2 (MIB File provided with the equipment)</li></ul>
<ul style="list-style-type: none"><li>• Inband Management of Remote Units over the E1 links</li></ul>
<ul style="list-style-type: none"><li>• NMS - Network Management System</li></ul>

## Power Supply

VCL-MX Version 3–DLX (Deluxe Version) – 4 E1 Multiplexer is powered by a -48V DC power supply, which drives the various sub-systems in it.

The following features are supported:

- Allows for power monitoring by LED
- Reverse polarity and inrush current limiting
- 1+1 Redundancy

**Technical Specifications:****E1 Interface**

Maximum Number of E1 Interfaces	4 E1 Interfaces with full capability to cross connect at DS-0, 64Kbps time-slot level, as well as to inter-connect to voice and digital data services between 4 incoming E1 Ports (i.e. 4 separate E1 Links)
Conformity (electrical)	G.703
Frame Structure	As per ITU (CCITT) G.704
Signaling	Channel Associated Signaling (ABCD programmable)
PCM Sampling Rate	8000 Samples / sec
Encoding Law	A Law as per ITU (CCITT)
Bit Rate	2048 Kbps $\pm$ 50 ppm
Code	HDB3
Nominal Impedance	120 $\Omega$ balanced / 75 $\Omega$ unbalanced
Peak Voltage of a mark For 120 $\Omega$ Balanced interface 75 $\Omega$ Unbalanced interface	3.0 V $\pm$ 0.3 V 2.37 V $\pm$ 0.237 V
Peak Voltage of a space For 120 $\Omega$ Balanced interface 75 $\Omega$ Unbalanced interface	0 V $\pm$ 0.3 V 0V $\pm$ 0.237 V
Nominal Pulse Width	244 ns
Pulse Mask	As per ITU (CCITT) Rec. G.703
Output Jitter	<0.05 UI (in the frequency range of 20Hz to 100 KHz)
Permissible Attenuation	6 dB at 1 MHz
Return Loss at: 51.2 KHz to 102.4 KHz 102.4 KHz to 2048KHz 2048KHz to 3072 KHz	>12dB > 18dB > 14dB
Jitter Tolerance	As per ITU (CCITT) G.823
Loss and recovery of frame alignment	As per clause 3 of ITU (CCITT) G.732
Loss and recovery of multi-frame alignment	As per clause 5.2 of ITU (CCITT) G.732

**2 Wire - Voice Frequency Interface(s) - FXS (VCL-CB-025)**

Number of Channels per Card	2
Interface Type	FXS
Maximum Number of Channels	20
Transmission performance	Fully Compliant to ITU (CCITT) G.712 (G.713, G.714) specification
Line Impedance	600 $\Omega$ (900 $\Omega$ optional)
Voice Channel Frequency	300Hz-3400Hz

Insertion Loss	-2.0dB Nominal (User adjustable)
Idle Channel Noise	≤ - 65dB
Return Loss	300Hz – 600Hz - ≥ 12dB 600Hz – 3400Hz - ≥ 15dB
Longitudinal Balance	≥ 46dB between 300Hz to 3400Hz
Ring Frequency	25Hz, (20 Hz, Optional)
Ring Voltage	≥ 75 volts RMS into a load of 5 R.E.N. with a 0.30 Erlang traffic pattern
Subscriber Loop Current	≥ 23mA into a subscriber loop of 1000 Ohms
Overload Level	+3.14dBm ± 0.5dBm
Battery Reversal	All channels
Dial Pulse Speed	8 -12 pps - Pulse Dialing/DTMF Dialing

### 2 Wire - Voice Frequency Interface(s) - FXS (VCL-CB-025-EXT)

Number of Channels per Card	2
Interface Type	FXS - EXT
Maximum Number of Channels	20
Transmission performance	Fully Compliant to ITU (CCITT) G.712 ( G.713, G.714) specification
Line Impedance	600 Ohms (900 Ohms optional)
Voice Channel Frequency	300Hz-3400Hz
Insertion Loss (nominal)	-2dB (user adjustable range of -2dB to -8dB)
User selectable range for insertion loss	1dB to 7dB
Input level minimum	-11dB
Input level maximum	3.2dB
Transmit Gain	0 to 16dB (user configurable)
Receive Attenuation	0 to 16dB (user configurable)
Idle Channel Noise	≤ -65dB
Return Loss	300Hz - 600Hz - ≥ 12dB 600Hz - 3400Hz - ≥ 15dB
Longitudinal Balance	≥ 46dB between 300Hz to 3400Hz
Ring Frequency	25 Hz (20Hz, Optional)
Ring Voltage	≥ 75 volts RMS into a load of 5 R.E.N. with a 0.30 Erlang traffic pattern
Subscriber Loop Current	23mA into a subscriber loop of 1000 ohms
Overload Level	+3.14dBm ± 0.5dBm
Battery Reversal	All channels
Dial Pulse Speed	8 -12 pps - Pulse Dialing/DTMF Dialing

**2 Wire - Voice Frequency Interface(s) - FXO (VCL-CB-030)**

Number of Channels per Card	2
Interface Type	FXO
Maximum Number of Channels	20
Transmission performance	Fully Compliant to ITU (CCITT) G.712 (G.713, G.714) specification
Line Impedance	600 $\Omega$ (900 $\Omega$ optional)
Voice Channel Frequency	300Hz-3400Hz
Insertion Loss / Gain	-2.0dB Nominal (User adjustable)
Idle Channel Noise	$\leq$ -65dB
Return Loss	300Hz - 600Hz - $\geq$ 12dB 600Hz - 3400Hz - $\geq$ 15dB
Longitudinal Balance	$\geq$ 46dB between 300Hz to 3400Hz
Ring Frequency	25 Hz (20Hz, Optional)
Ring Voltage	$\geq$ 75 volts RMS into a load of 5 R.E.N. with a 0.30 Erlang traffic pattern
Subscriber Loop Current	$\geq$ 23mA into a subscriber loop of 1000 ohms
Overload Level	+3.14dBm $\pm$ 0.5dBm
Battery Reversal	All channels
Dial Pulse Speed	8 -12 pps - Pulse Dialing/DTMF Dialing

**Hot-Line Interface Card (VCL-CB-027)**

Number of Channels per Card	2
Interface Type	Hot-Line
Maximum Number of Channels	20
Transmission performance	Fully compliant to ITU (CCITT) G.712 (G.713, G.714) specification
Line Impedance	600 $\Omega$
Voice Channel Frequency	300Hz-3400Hz
Insertion Loss	-2.0dB Nominal
Idle Channel Noise	$\leq$ -65dB
Return Loss	300Hz - 600Hz - $\geq$ 12dB 600Hz - 3400Hz - $\geq$ 15dB
Longitudinal Balance	$\geq$ 46dB between 300Hz to 3400Hz
Ring Frequency	25 Hz (20Hz, optional)
Ring Voltage	$\geq$ 75 volts RMS into a load of 5 R.E.N. with a 0.30 Erlang traffic pattern
Subscriber Loop Current	$\geq$ 23mA into a subscriber loop of 1000 Ohms
Overload Level	+3.14dBm $\pm$ 0.5dBm
Battery Reversal	All channels
Dial Pulse Speed	10 pps - Pulse Dialing / DTMF Dialing

**2 Wire / 4 Wire Voice Frequency Interface(s) E&M (VCL-MX-035-EXT)**

Number of Channels per Card	2
Interface Type	2W / 4W E&M – Ext, Type V
Maximum Number of Channels	20
Transmission performance	Fully compliant to ITU (CCITT) G.712 (G.713, G.714) specification
Line Impedance	600 $\Omega$ (900 $\Omega$ optional)
Voice Channel Frequency	300Hz-3400Hz
Insertion Loss / Gain	-2.0 dB nominal (User adjustable)
Idle Channel Noise	$\leq$ -65dB
Return Loss – 2 wire	300Hz - 600Hz - $\geq$ 12dB 600Hz - 3400Hz - $\geq$ 15dB
Return Loss – 4 wire	300Hz - 3400Hz - $\geq$ 20dB
Longitudinal Balance	$\geq$ 46dB between 300Hz to 3400Hz
Overload Level	+3.14dBm $\pm$ 0.5dBm
Dial Pulse Speed	Pulse / MFC Dialing / DTMF Dialing

**E&M 2 Wire / 4 Wire Voice Frequency Interface (VCL-MX-035)**

Number of Channels per Card	2
Interface Type	2W / 4W E&M, Type V
Maximum Number of Channels	20
Transmission performance	Fully compliant to ITU (CCITT) G.712 specification
Line Impedance	600 $\Omega$
Voice Channel Frequency	300Hz-3400Hz
Insertion Loss / Gain	-2.0 dB Nominal
Idle Channel Noise	$\leq$ -65dB
Return Loss	300Hz - 600Hz - $\geq$ 12dB 600Hz - 3400Hz - $\geq$ 15dB
Longitudinal Balance	$\geq$ 46dB between 300Hz to 3400Hz
Overload Level	+3.14dBm $\pm$ 0.5dBm
E & M Signaling Rate	10pps

**GEN GEN / Magneto Interface Card (VCL-MX-1478-GEN)**

Number of Channels per Card	2
Interface Type	Magneto, 2-wire (GEN-GEN)
Line Impedance	600 $\Omega$
Voice Channel Frequency	300Hz-3400Hz
Ringing generator frequency	25Hz
Ring Voltage	75 volts RMS
Maximum Number of Channels	20
Transmission performance	Fully compliant to ITU (CCITT) G.712 specification
Insertion Loss / Gain	-2.0dB Nominal
Idle Channel Noise	$\leq$ -65dB
Return Loss	300Hz - 600Hz - $\geq$ 12dB 600Hz - 3400Hz - $\geq$ 15dB
Longitudinal Balance	$\geq$ 46dB between 300Hz to 3400Hz
Overload Level	+3.14dBm $\pm$ 0.5dBm

**Low Speed Data Interface RS232 / V.24 (VCL-CB-045)**

Interfaces	RS232
Number of Interfaces per Card	2
Maximum Number	20
Conformity	RS232
Mode	Asynchronous
Bit Rate	50 Kbps to 19.2 Kbps
User Interface	DCE
Character Length	5 / 6 / 7 / 8 (auto-select)
Stop Bits	1 / 1.5 / 2 (auto-select)
Parity	Even / Odd / 0's / 1's / none (Auto-Select)

**G.703 @ 64kbps, Synchronous Data Interface (VCL-CB-060)**

Interface	G.703 @ 64 Kbps
Number of Interfaces per Card	2
Maximum Number	20
Conformity	To (CCITT) Rec. G.703
Mode	Synchronous, Co-directional
Bit Rate	64Kbps

**Universal Data Interface: High Speed Synchronous “n x 64” Data Interface Type - User Configurable DCE-DTE (VCL-MX-59)**

Interface	V.35, V.36, X.21, RS530, RS442, V.11
Number of Interfaces per Card	1, (“N” x 64KBits / sec. per card)
Maximum Number of Interfaces per system	3
Bandwidth	(“N” x 64 Kbits / sec. interface maximum value of “N” =30)-user selectable
Conformity	Universal user-configurable as above
Mode	Synchronous
Bit Rate	64 Kbps to 1920 Kbps
User Interface	DCE/DTE (user programmable for DTE / DCE mode)

**High Speed Synchronous “n x 64” Data Interface Type: 10BaseT Ethernet Bridge (VCL-MX-10BaseT)**

Interface	10BaseT (bridge)
Number of Interfaces per Card	1
Maximum Number of Interfaces per system	3
Bandwidth	(“N” x 64Kbits/sec. interface maximum value of “N” =30) - user selectable
Conformity	10BaseT Ethernet Bridge

Mode	Synchronous
Bit Rate	64 Kbps to 16Mbps
User Interface	10BaseT

**High Speed Synchronous “n x 64” Data Interface Type: V.35 (VCL-MX-59)**

Interface	V.35
Number of Interfaces per Card	1, (“N” x 64Kbits/sec. per card)
Maximum Number of Interfaces per system	3
Bandwidth	(“N” x 64Kbits / sec. interface maximum value of “N” = 30) - user selectable
Conformity	V.35
Mode	Synchronous
Bit Rate	64 Kbps to 1920 Kbps
User Interface	DCE

**High Speed Synchronous “n x 64” Data Interface Type: V.36 (VCL-MX-59)**

Interface	V.36
Number of Interfaces per Card	1, (“N” x 64KBits/sec. per card)
Maximum Number of Interfaces per system	3
Bandwidth	(“N” x 64Kbits / sec. interface maximum value of “N” = 30) - user selectable
Conformity	V.36
Mode	Synchronous
Bit Rate	64 Kbps to 1920 Kbps
User Interface	DCE



**High Speed Synchronous “n x 64” Data Interface Type: X.21 (VCL-MX-59)**

Interface	X.21
Number of Interfaces per Card	1, (“N” x 64Kbits/sec. per card)
Maximum Number of Interfaces per system	3
Bandwidth	(“N” x 64Kbits / sec. interface maximum value of “N” = 30) - user selectable
Conformity	X.21
Mode	Synchronous
Bit Rate	64 Kbps to 1920 Kbps
User Interface	DCE

**High Speed Synchronous “n x 64” Data Interface Type: V.11 (VCL-MX-59)**

Interface	V.11
Number of Interfaces per Card	1, (“N” x 64Kbits/sec. per card)
Maximum Number of Interfaces per system	3
Bandwidth	(“N” x 64Kbits / sec. interface maximum value of “N” = 30) - user selectable
Conformity	V.11
Mode	Synchronous
Bit Rate	64 Kbps to 1920 Kbps
User Interface	DCE

**High Speed Synchronous “n x 64” Data Interface Type: RS442**

Interface	RS442
Number of Interfaces per Card	1, (“N” x 64Kbits/sec. per card)
Maximum Number of Interfaces per system	3
Bandwidth	(“N” x 64Kbits / sec. interface maximum value of “N” = 30) - user selectable
Conformity	RS442
Mode	Synchronous
Bit Rate	64 Kbps to 1920 Kbps
User Interface	DCE

**High Speed Synchronous “n x 64” Data Interface Type: RS530 (VCL-MX-59)**

Interface	RS530
Number of Interfaces per Card	1, (“N” x 64Kbits/sec. per card)
Maximum Number of Interfaces per system	3
Bandwidth	(“N” x 64Kbits / sec. interface maximum value of “N” = 30) - user selectable
Conformity	RS530
Mode	Synchronous
Bit Rate	64 Kbps to 1920 Kbps
User Interface	DCE

**Digital I/O Interface Card (Digital TTL Signal Transfer Card) (VCL-MX-048)**

**Description:** This interface card provides 8 digital I/Os which may be used to either extend digital I/O’s (logic high / low) signals between any two E1 Multiplexers or operate switches remotely (using logic high/low) signals between any two multiplexers. Drivers / Sense Logic operate using external voltage and ground references).

**Digital I/O’s - Type I**

Number of Digital I/Os per 64 Kbps time-slots / per Interface Card	8 Digital In / 8 Digital Out / (Logic High / Low) Interfaces
Digital Drivers (current source type)	8
Max Source current	100mA
External Ref Voltage Range	5 Volts to 30 Volts DC
External Reference Voltage	Required
Minimum Load Resistance @ 5V	50R
Minimum Load Resistance @ 30V	300R
Digital Sensor (current sink type)	8
Maximum sink current	30mA
Voltage Range	5 Volts
External Ground Reference	Required

**OR**

**Digital I/Os - Type II**

Digital Drivers (current sink type)	8
Maximum sink current	100mA
Voltage Range	5 Volts to 30 Volts DC
External Ground Reference	Required
Digital Sensor (current source type)	8
Maximum sink current	30mA
Voltage Range	5 Volts to 30 Volts DC
External Ground Reference	Required

**Analog I/O Interface Card (Dry Relay Contacts) (VCL-MX-047)**

**Description:** This interface card provides 8 Analog I/Os which may be used to extend either Dry Relay Contacts (Relay Normally-Open or Relay Normally-Close) or operate switches remotely (using 2A Dry Relay Contacts) between any two multiplexers using a 64 Kbps time-slot. The Dry Relay Contacts are rated at maximum 2 Amps, 30 Volts DC.

**Relay Specifications (Drivers – per interface card)**

Maximum Number of Relay Ports	8
Maximum Switching Power	60 W
Maximum Switching Voltage	30V DC
Maximum Switching Current	2 Amps
Typical Number of Operation	> million

**Dry Contacts Sensors per interface card**

Maximum Number of Dry Contact Sensors	8
Maximum Current	30mA
Typical Current	30mA
Reference Source Voltage	3.3 Volts

**OAM (Operation and Maintenance) SNMP, Telnet Port Specifications**

Network Interface	RJ-45 Ethernet 10BaseT or 100BaseT-TX (auto sensing) Support auto MDI/MDI X
Compatibility	Ethernet Version 2.0 IEEE802.3
Protocols Supported	UDP/IP, TCP/IP, Telnet, ICMP and SNMP
LEDs	10Base-T and 100Base-TX Activity, full/half duplex
Management	SNMP Telnet Login
EMI Compliance	<ul style="list-style-type: none"> <li>- Radiated and conducted emissions – complies with Class B limits of EN55022:1998</li> <li>- Direct and Indirect ESD – complies with EN55024:1998</li> <li>- RF Electromagnetic Field Immunity – complies with EN55024:1998</li> <li>- Electrical Fast Transient/Burst Immunity – complies with EN55024:1998</li> <li>- Power Frequency Magnetic Field Immunity – complies with EN55024:1998</li> <li>- RF Common Mode Conducted Susceptibility – complies with EN55024:1998</li> </ul>

**Management Port and Control Interfaces**

<ul style="list-style-type: none"> <li>• Serial Management Port - RS232 Interface</li> </ul>
<ul style="list-style-type: none"> <li>• USB Serial Port</li> </ul>
<ul style="list-style-type: none"> <li>• 10/100BaseT Telnet over a TCP/IP Network</li> </ul>

**System Access and Management**

<ul style="list-style-type: none"> <li>• Windows XP and Windows 7 compatible GUI (Graphical User Interface)</li> </ul>
<ul style="list-style-type: none"> <li>• Telnet - CLI (Command Line Interface)</li> </ul>
<ul style="list-style-type: none"> <li>• SNMP V2 (MIB File provided with the equipment)</li> </ul>
<ul style="list-style-type: none"> <li>• Inband Management of Remote Units over the E1 links</li> </ul>
<ul style="list-style-type: none"> <li>• NMS - Network Management System</li> </ul>

**Protection**

Central Office Terminal and Remote Terminal are protected against power surges and transients occurring from lightning and electric induction as per CCITT Rec. Table I/K-20 towards line side.

## Power Supply

Input DC Voltage	-48V DC (nominal)
Range of Input	-36V to -72V DC
Output Voltage	+5V, -5V, filtered -48V (for terminal cards)
Full Load Output Current	16A at +5V
Input Voltage Reversal Protection	Provided in the Card
Over Current Protection	16.8A for +5V
Short Circuit Protection	Current limit - 16.8A. Recovers on removal of short
Efficiency at Full Load	>91%
Ripple at Full Load	<5mVrms
Spike at Full Load	<50mV
Maximum Power Consumption	25 watt – with all 20 Voice & Data Circuits active

## Power Supply

VCL-MX Version 3–DLX (Deluxe Version) – 4 E1 Multiplexer is powered by a -48V DC power supply, which drives the various sub-systems in it.

The following features are supported:

- Allows for power monitoring by LED
- Reverse polarity and inrush current limiting
- 1+1 Redundancy

## Telco Networks Providing Voice and Data Services

VCL-MX Version 3–DLX (Deluxe Version) – 4 E1 Multiplexer is an ideal platform to provide high-end data and voice requirement of clients. VCL-MX Version 3 – DLX – 4 E1 Multiplexer can be installed at the regional and gateway Points of Presence (POP) locations in order to cater to the ever-growing data requirements of the customers while supporting legacy services at the same time.

The advantage that the VCL-MX Version 3–DLX (Deluxe Version) – 4 E1 Multiplexer provides the Telecom Service provider is as follows:

- The VCL-MX Version 3–DLX (Deluxe Version) – 4 E1 Multiplexer enables network simplifications by collapsing networks, nodes and services into a single multi service device. A smaller number of higher-density nodes and node types enable cost savings as a result of a smaller, more homogenous network to manage.
- The flexible architecture of the VCL-MX Version 3–DLX (Deluxe Version) – 4 E1 Multiplexer series ensures that the network is future proof, and the service provider has the flexibility of choosing a technology he thinks useful at any time in the future with minimal investment.

## Applications

The VCL VCL-MX Version 3–DLX (Deluxe Version) – 4 E1 Multiplexer can be configured in linear and bus architectures. It can be used in the core of the network to provide high-speed backbone network.

The VCL-MX Version 3–DLX (Deluxe Version) – 4 E1 Multiplexer could provide the core for cellular or mobile networks between Mobile Switching Centers with subtended.

VCL-MX Version 3–DLX (Deluxe Version) – 4 E1 Multiplexer could also be used to provide versatile cross-connect functionality to connect telephone exchanges in VCL-MX Version 3–DLX (Deluxe Version) – 4 E1 Multiplexer in dense metro areas.

## Application Diagram

### Application 1: Providing Voice and Data Services on Microwave Radio Links

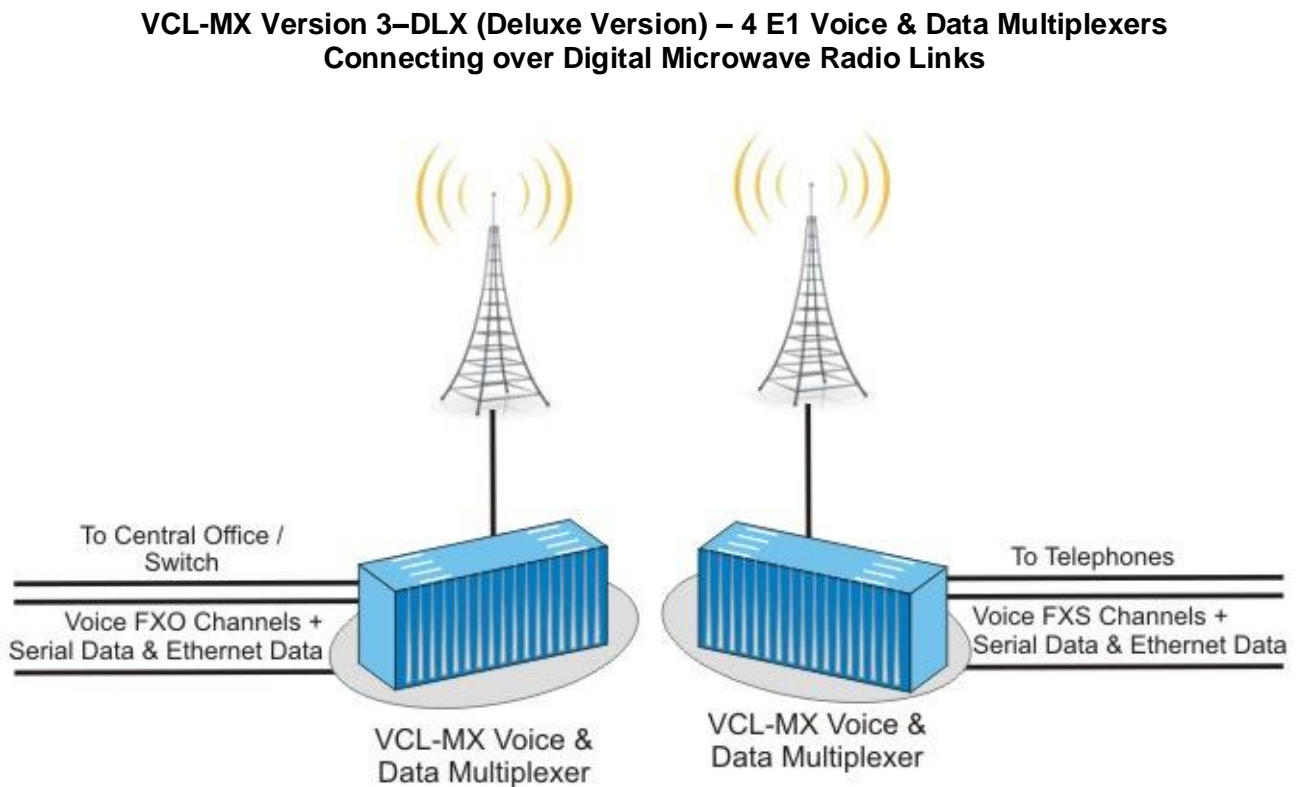

**Application 2: Providing Voice and Data Services on Optical Fiber**

**VCL-MX Version 3-DLX (Deluxe Version) – 4 E1 Voice & Data Multiplexers  
Connecting over Optical Fiber Links**

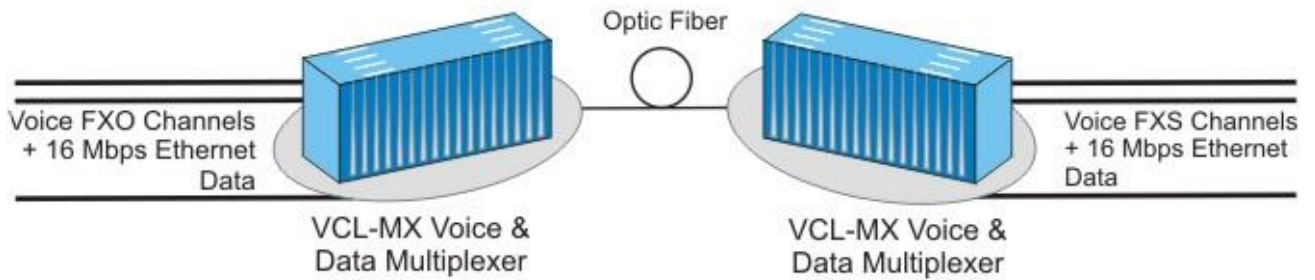

**Application 3: Transporting E & M Channels**

**VCL-MX Version 3-DLX (Deluxe Version) – 4 E1 Voice & Data Multiplexers  
Connecting at the Central Office/Switch - E & M Interfaces**

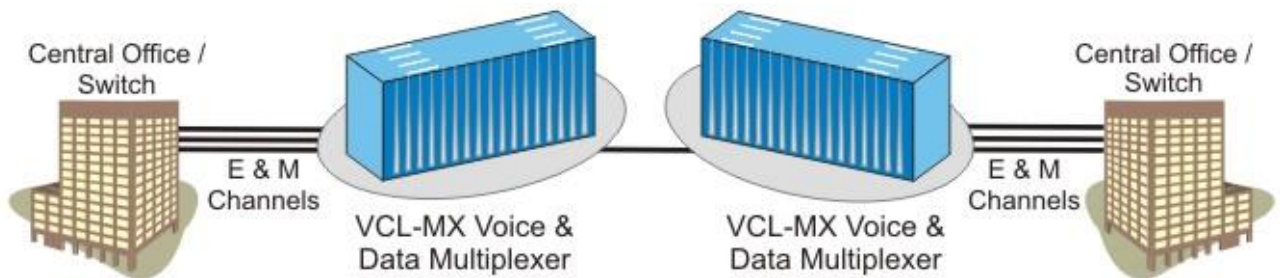

#### Application 4

##### VCL-MX Version 3 – DLX – 4 E1 Voice & Data Multiplexers Using in a Subscriber Loop Point to Point or Drop/Insert Application

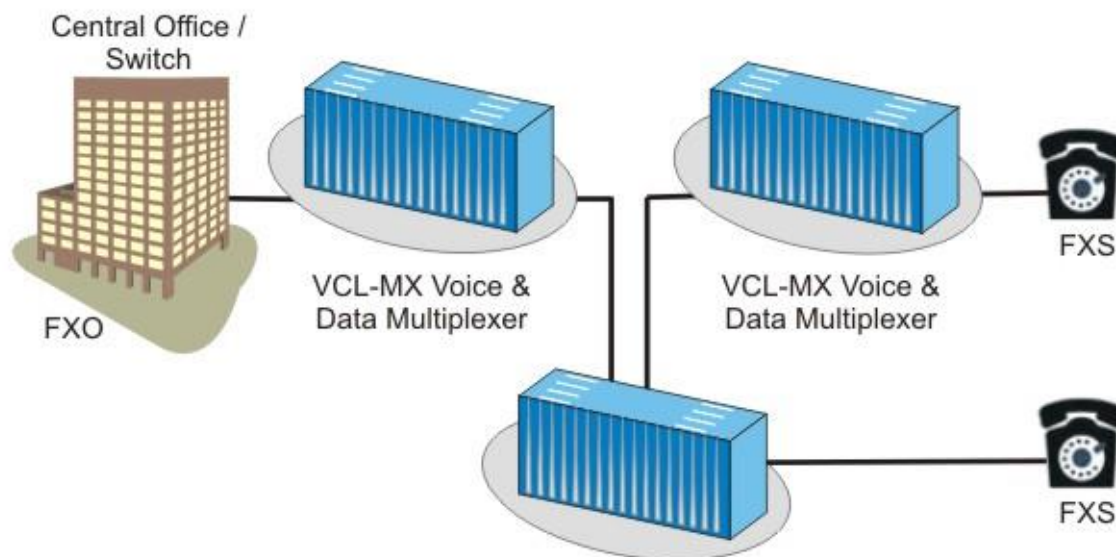

**FXO/JNC 2 wire exchange loop interface card**  
**FXS/SLC 2 wire subscriber loop interface card**

#### Application 5: Providing Synchronous “n x 64” Kbps Data Interfaces



**VCL-MX Version 3-DLX (Deluxe Version) – 4 E1 Voice & Data Multiplexer**

**Providing Synchronous (X.21, V.35, V.36, RS530)  
“n x 64” Kbps Data Interfaces**

**DCE- Remote DCE Configuration  
Data Interface Card (Application A)**

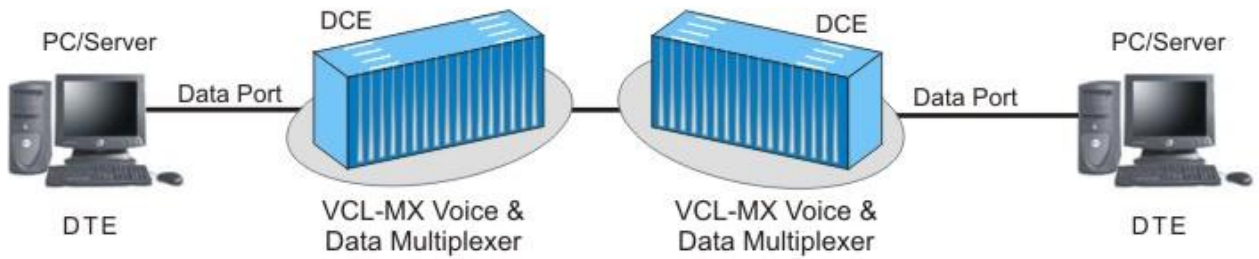

**DCE- Remote DTE Configuration  
Data Interface Card (Application B)**

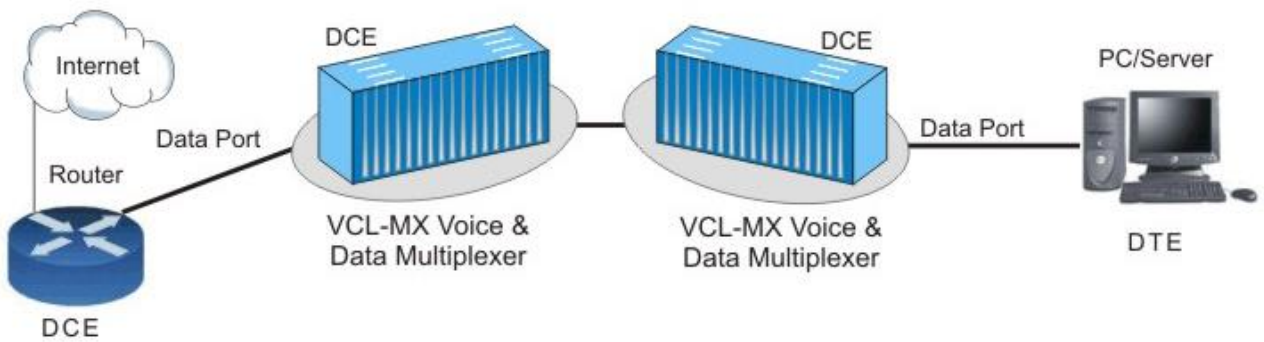

**Application 6: Providing Voice and Synchronous “n x 64” Kbps Data Interfaces**

**VCL-MX Version 3-DLX (Deluxe Version) – 4 E1 Voice & Data Multiplexer**

**Providing Voice and Synchronous (V.11, X.21, V.35, V.36, RS442, RS530)  
“n x 64” Kbps Data Interfaces**

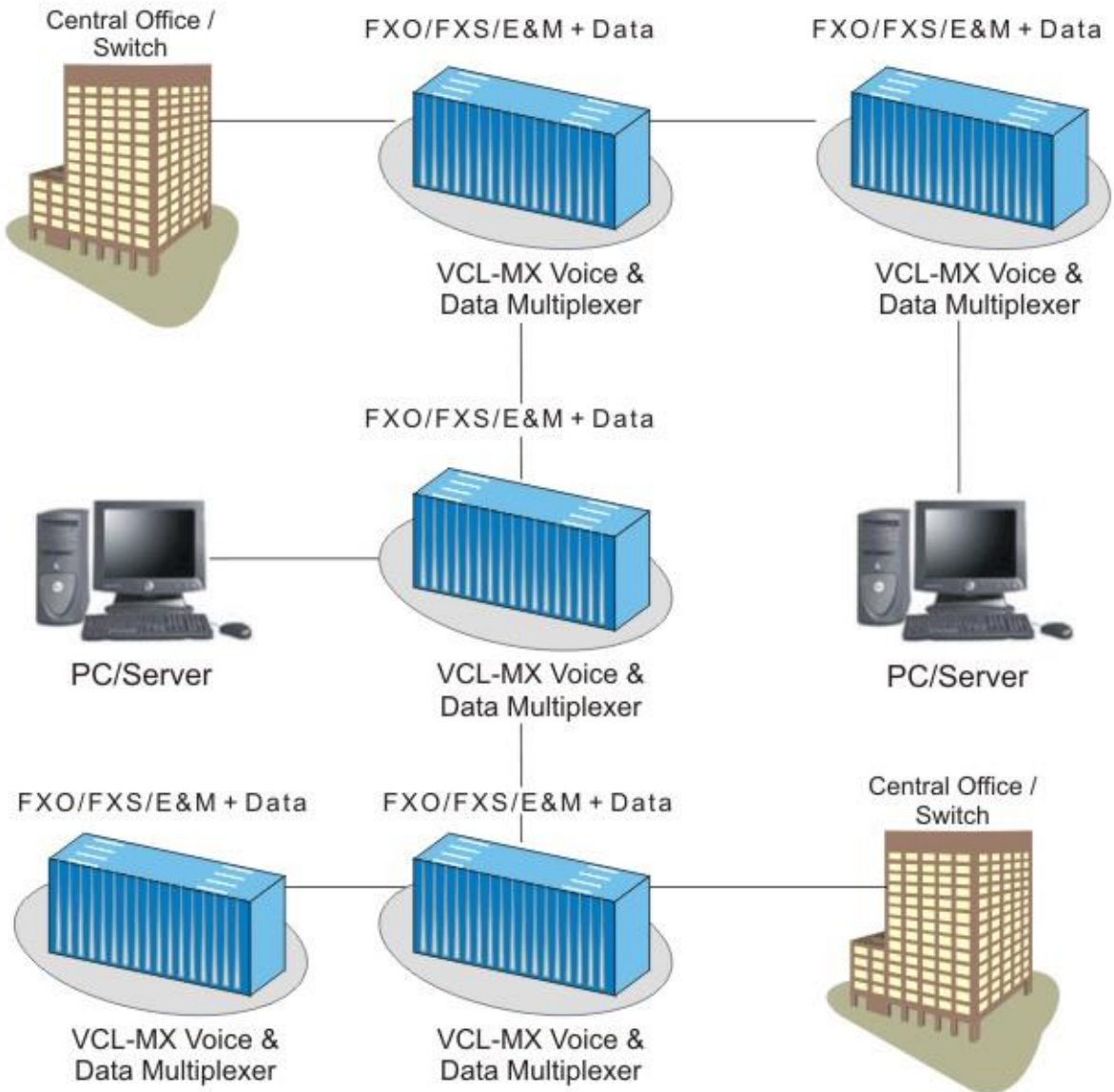

**Application 7: For providing Hybrid Voice and Data Services**

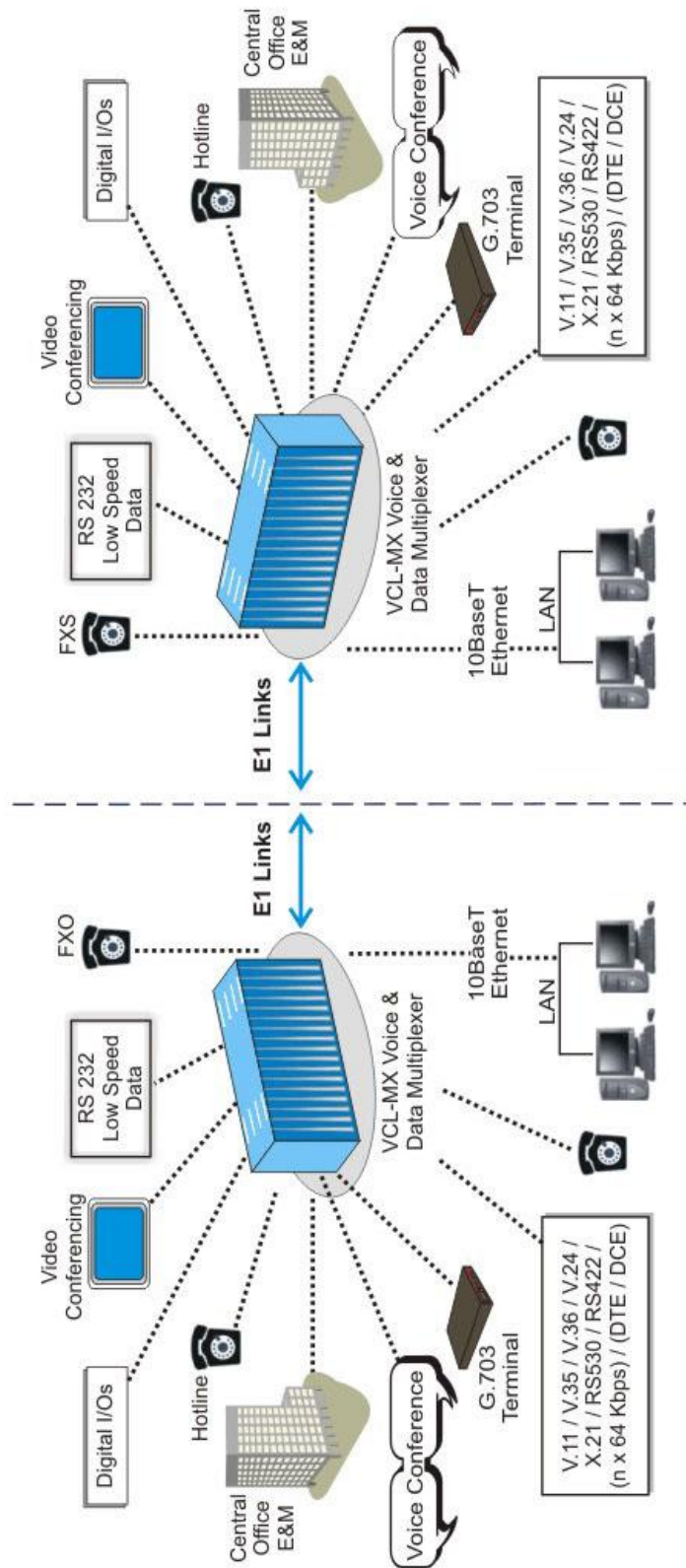

**Application 8:**

**VCL-MX Version 3-DLX (Deluxe Version) – 4 E1 Voice & Data Multiplexer  
used in Add-Drop, Tree and Star Configuration**

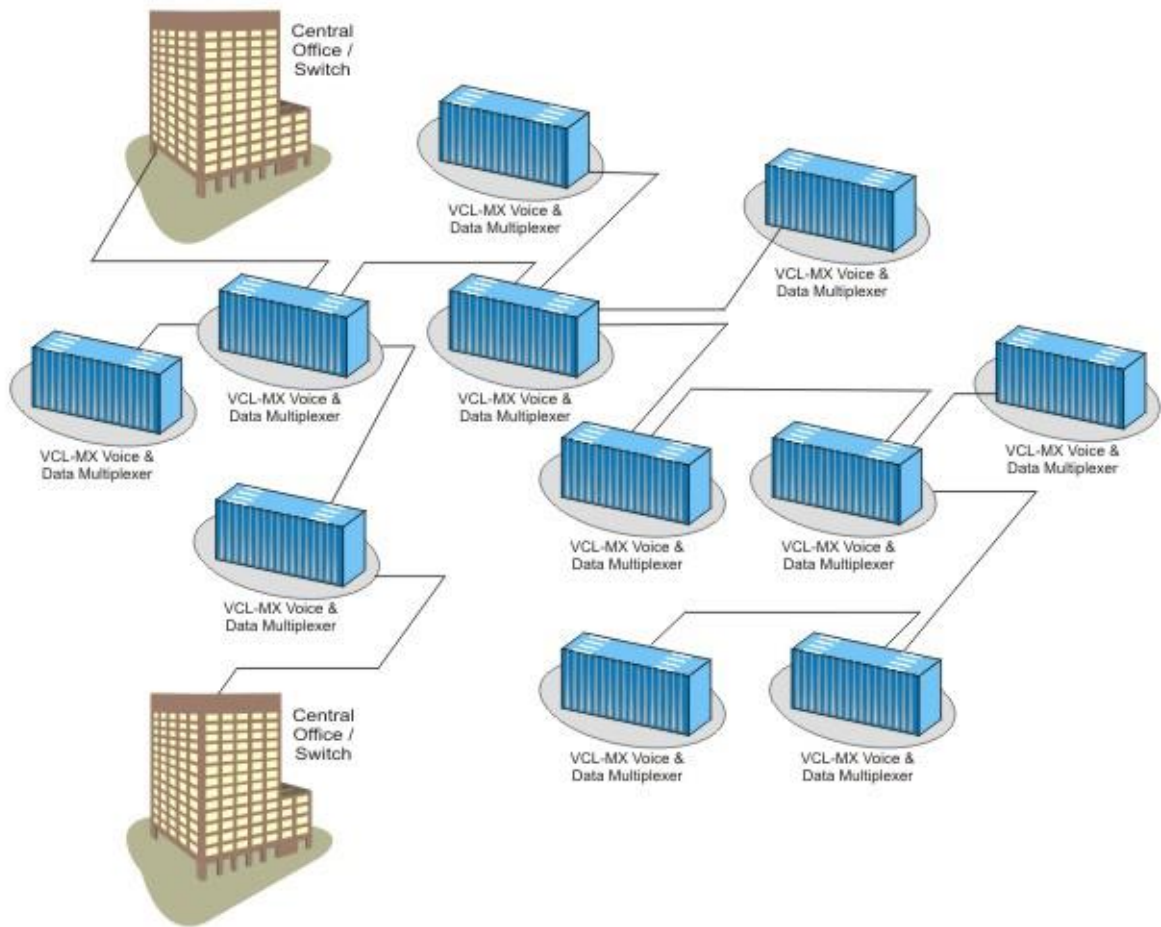

### Ordering Information

<b>VCL-MX E1 Core System (Common Equipment)</b>			
S. No.	Part #	Product Description	Qty
1.	VCL-MX-015-3-DLX	4 x E1 Control Card (4 x E1 non-blocking cross-connect at 64Kbps (DS-0) level). Supports point-to-point, point-to-multi-point, add-drop, tree and star applications	1
2.	VCL-MX-003-1487-DLX	19" Shelf 3U High (Sub-rack) fitted with Connectorized Backplane to accommodate Voice, 64Kbps Data Channels PLUS "n" x 64Kbps Data Channels [E1 75Ω / 120Ω DB25 (Female)] [13 Slots (10 + 3) for User Configurable Interface Cards]	1
3.	VCL-MX-010-1497-MON	(-) 48VDC Input Power Supply Card, [Output : +5VDC, -5VDC, filtered -48VDC (for terminal cards)] Note: Please order 2 numbers for 1 + 1 redundancy	1
4.	VCL-OAM-1490-5.0	Management Card [RJ45, DB9F COM, USB] OAM - Operations and Management Card for connecting the multiplexer to be managed in a LAN - allows the USER to assign a unique IP address to each multiplexer connected in a LAN to be managed from a single point. Telnet, SNMP (V2)	1

<b>VCL-MX, User Configurable Interfaces</b>			
S. No.	Part #	Product Description	Qty
1.	VCL-CB-025	2 Port VF, RT (FXS) @ @ 64Kbps Central Office Remote Terminal Line Interface Card 10 (max) per System / Chassis	1
2.	VCL-CB-027	2 Port VF, Hot-Line (FXS - Ring-Down) @ 64Kbps Line Interface Card 10 (max) per System / Chassis	1
3.	VCL-CB-030	2 Port VF, CO (FXO) @ 64Kbps Central Office Line Interface Card 10 (max) per System / Chassis	1
4.	VCL-CB-035-EXT	2 Port VF, E&M, 2 Wire / 4 Wire Trunk Line Interface Card (Programmable Tx and Rx settings / VF range 0 to -15dB (gain), 10 (max) per System / Chassis	1
5.	VCL-MX-040-1498-MON	Ring Generator Card, Central Office Ring Generator 1 per System/ Chassis with FXS Interfaces	1

6.	VCL-CB-045	2 Port, RS232, 50 Kbps to 19.2 Kbps DCE Asynchronous Data Interface Card, 10 (max) per System / Chassis	1
7.	VCL-MX-047	8 Port, Analog I/O Interface Card. Either extend Dry Relay Contacts (Relay Normally - Open or Relay Normally - Close) or operate switches remotely (using 2A Dry Relay Contact rated at maximum 2 Amps, 30V DC) between any two multiplexers using a 64 Kbps time-slot. 3 (max) per System / Chassis	1
8.	VCL-CB-048	8 Port, Digital I/O Card. Either extend Digital I/O's (logic high / low) signals between any two E1 Multiplexers or operate switches remotely (using logic high / low) signals between any two multiplexers. 3 (max) per System / Chassis	1
9.	VCL-MX-059	1 Port, Universal Synchronous Data Interface Card V.35, V.36, RS530, X.21, V.11, DTE/DCE, "N" x 64Kbps Synchronous Data Interface, User Selectable Data Rate of "N" (1 thru 30) - DCE or DTE (User Configurable), 3 (max) per System / Chassis	1
10.	VCL-CB-060	2 Port, G.703 @ 64kbps, Synchronous Co-directional Data Interface 10 (max) per System / Chassis	1
11.	VCL-MX-081	1 Port, Fractional E1 - N x 64Kbps Data Interface Card User Selectable Data Rate of "N" (1 thru 31), 3 (max) per System / Chassis	1
12.	VCL-MX-1478-GEN	2 Port, GEN GEN / Magneto 2-wire Interface Card 10 (max) per System / Chassis	1
13.	VCL-MX-10BaseT Bridge	1 Port, Integrated 10BaseT Ethernet Bridge 64Kbps to 16Mbps High Speed Synchronous Data Interface Card User Selectable ("n" x 64) Bandwidth. "n" = 1 thru 30, 3 (max) per System / Chassis	1

### Ordering Information

<b>Cables and Accessories</b>			
S. No.	Part #	Product Description	Qty
1.	VCL-HRNS 1022	FXS/FXO 2 Port Connectorized Cable [2RJ11M-Open] [1 cable each FXO/FXS card]	1
2.	VCL-HRNS 1068	E&M 1 Port Connectorized Cable [RJ11M6P6C-Open] [2 cables each E&M card]	1
3a.	VCL-HRNS 1018	RS232 1 Port Connectorized Cable [RJ11M6P6C-DB9F] [2 cables each RS232 card] OR	1
3b.	VCL-HRNS 1074	RS232 1 Port Connectorized Cable [RJ11M6P6C-DB9M] [2 cables each RS232 card]	1
4.	VCL-HRNS 1225AIO	AIO 8 Port Connectorized Cable [DB25M-Open] [1 cable each AIO card]	1
5.	VCL-HRNS 1225DIO	DIO 8 Port Connectorized Cable [DB25M-Open] [1 cable each DIO card]	1
6a.	VCL-HRNS 1073V35F	V.35 1 Port Connectorized Cable [DB25M-Winchester F] [1 cable each V.35 card] OR	1
6b.	VCL-HRNS 075V35M	V.35 1 Port Connectorized Cable [DB25M-Winchester M] [1 cable each V.35 card]	1
7a.	VCL-HRNS 1225V11F	V.36/RS530/V.11 1 Port Connectorized Cable [DB25M-DB37F] [1 cable each V.36/RS530 Card] OR	1
7b.	VCL-HRNS 1225V11M	V.36/RS530/V.11 1 Port Connectorized Cable [DB25M-DB37M] [1 cable each V.36/RS530 card]	1
8a.	VCL-HRNS 1225X21F	X.21 1 Port Connectorized Cable [DB25M-DB25F] [1 cable each X.21 Card] OR	1
8b.	VCL-HRNS 1225X21M	X.21 1 Port Connectorized Cable [DB25M-DB25M] [1 cable each X.21 Card]	1
9.	VCL-HRNS 1020	G.703 1 Port Cross Connectorized Cable [RJ11M-RJ45M] [2 cables each G.703 card]	1
10.	VCL-HRNS 1076	G.703 1 Port Parallel Connectorized Cable [RJ11M-RJ45M] [2 cables each G.703 card]	1

11.	VCL-HRNS 1225FE1P	Fractional E1 Parallel Connectorized Cable [DB25M-RJ45M] (1 cable each card)	1
12.	VCL-HRNS 1225FE1C	Fractional E1 Cross Connectorized Cable [DB25M-RJ45M] (1 cable each card)	1
13.	VCL-HRNS 1225LBRJ45M	LAN Bridge Connectorized Cable [DB25M-RJ45M] [1 cable each Integrated 10BaseT Bridge card]	1
14.	VCL-HRNS	GEN GEN / Magneto 2 Port Connectorized Cable [1 cable each GEN GEN / Magneto card]	1
15a.	VCL-HRNS 1225- 4E1O	E1 4 Port Connectorized Cable [DB25M-Open] [1 cable each Chassis] OR	1
15b.	VCL-HRNS 1225- 4E1RJ45M	E1 4 Port Connectorized Cable [DB25M-4xRJ45M] [1 cable each Chassis]	1
16.	UMIKitMXV3DLX	System Core Cables, Installation Accessories, Documentation, System User Manual, System User Manual Disk etc	1

### Ordering Information

<b>Power Supply (External) AC to DC Converter</b>			
<b>S. No.</b>	<b>Part #</b>	<b>Product Description</b>	<b>Qty</b>
1.	VCL-EP5A 0002	Power Supply (External) AC to DC Converter, Portable Adapter Version, PW-065A-1Y48F1, Universal AC Input [100-240VAC~2A, 50-60Hz] to DC Output [(-) 48VDC~1.35A 65W] [1 output]	1
2.	VCL-ACDC-48-50W- 1.1A	Power Supply (External) AC to DC Converter Portable Desktop Version, Universal AC Input [93VAC-276VAC, 47Hz-63Hz] to DC Output [(-) 48VDC~1.10A 50W] [1 Fused output]	1
3.	VCL-ACDC-48-150W- 3.2A	Power Supply (External) AC to DC Converter Portable Desktop Version, Universal AC Input [93VAC-276VAC, 47Hz-63Hz] to DC Output [(-) 48VDC~3.2A 150W] [1 Fused output]	1
4.	VCL-ACDC-48-150W- 3.2A-RK	Power Supply (External) AC to DC Converter 19"2U Rack Mount Version, Universal AC Input [93VAC-276VAC, 47Hz-63Hz] to DC Output [(-) 48VDC~3.20A 150W] [4 Fused outputs]	1



### Ordering Information

<b>E1, 120 Ohms (RJ45F) to 75 Ohms (BNCF) Converter</b>			
<b>S. No.</b>	<b>Part #</b>	<b>Product Description</b>	<b>Qty</b>
1.	VCL-EMOD 0192 G.703 Balun	G.703 Balun 1xE1 [120Ω RJ45F] to 1xE1 [75Ω 2xBNCF] Converter, 1xE1 Module (Tx / Rx) [RJ45 / BNC cables not included]	1
2.	VCL-EMOD 0133 G.703 Balun	G.703 Balun 1xE1 [120Ω RJ45F] to 1xE1 [75Ω 2xBNCF] Converter, 1xE1 Module (Tx / Rx) [RJ45 / BNC cables not included]	1
3.	VCL-1477-CON-120- RJ45F-75-BNCF-16	16xE1, 120Ω [16xRJ45F] to 75Ω [32xBNCF] Converter Panel 19" Metal case 2U High Rack Mount Version [RJ45 / BNC cables not included]	1
4.	VCL-HRNS 1011	E1 Cross Connectorized Cable [RJ45M-RJ45M, 3m]	1
5.	VCL-HRNS 1010	E1 Parallel Connectorized Cable [RJ45M-RJ45M, 3m]	1
6.	VCL-HRNS 1247	BNC 75 Ohm Connectorized Cable [BNCFM-BNCFM, 3m]	1

Notes: \_\_\_\_\_

\_\_\_\_\_

\_\_\_\_\_

\_\_\_\_\_

\_\_\_\_\_

Technical specifications are subjects to changes without notice.  
Revision 10 – November 10, 2016.

**U.K.**

**Valiant Communications (UK) Ltd**

1, Acton Hill Mews,  
310-328 Uxbridge Road,  
London W3 9QN, United Kingdom  
**E-mail:** gb@valiantcom.com

**U.S.A.**

**Valcomm Technologies Inc.**

4000 Ponce de Leon, Suite 470  
Coral Gables, FL 33146  
United States of America  
**E-mail:** us@valiantcom.com

**INDIA**

**Valiant Communications Limited**

71/1, Shivaji Marg,  
New Delhi - 110015,  
India  
**E-mail:** mail@valiantcom.com